

Article number: 2030120M20200A2UK

Description: E+G levelling foot  
GN 30-120-M20-200-A2-UK

Note: UK With nut, Hexagon socket at the top, Wrench flat at the bottom

## Measures

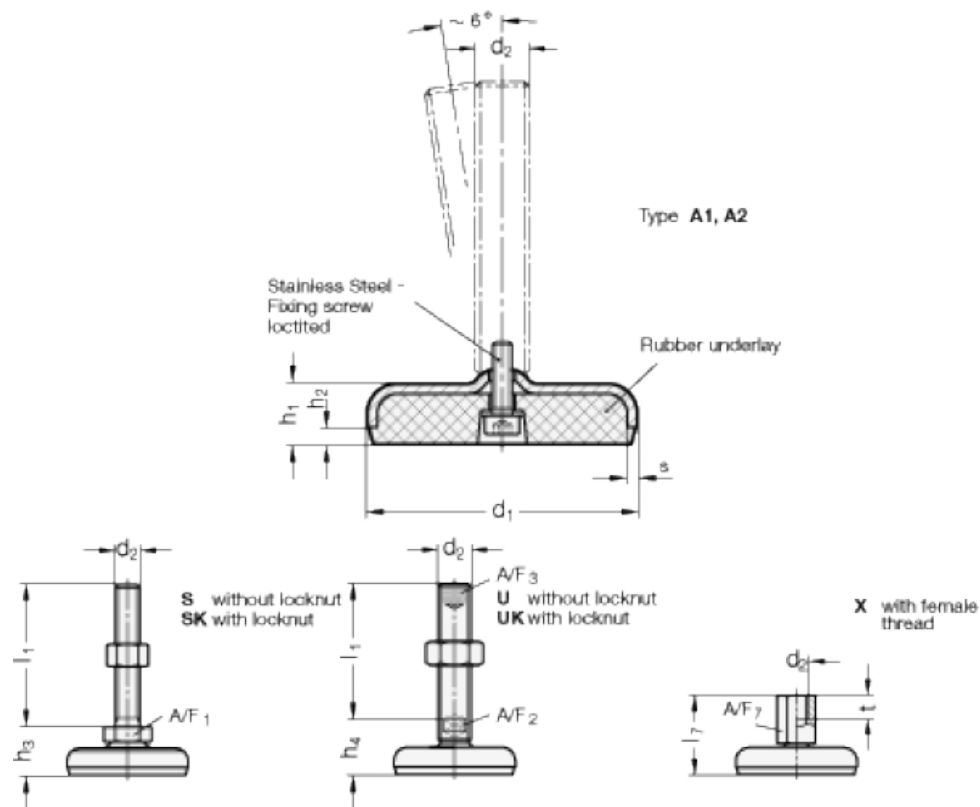

A/F2 = 15

s = 4

A/F3 = 10

$d_1$  = 120

$d_2$  = M20

$h_1$  = 22

$h_2$  = 6

$h_4$  = 39

$l_1$  = 200